

リボンA (5個)



■ = 接着芯をはる位置

※数字のないところは1cmの縫い代をつけます。

36・37表布の裁ち方

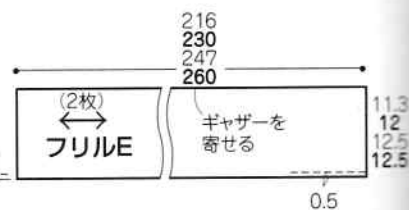
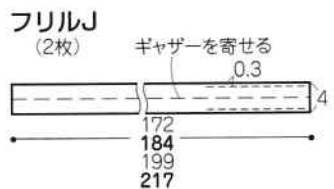
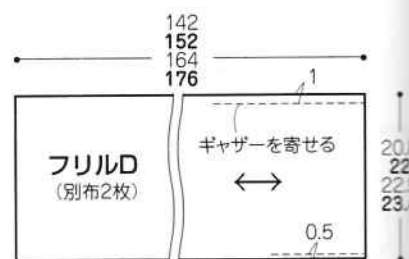
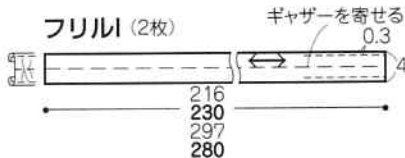
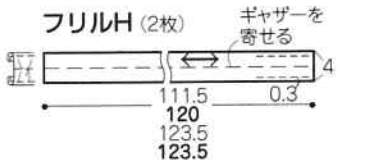
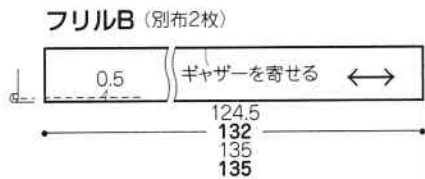
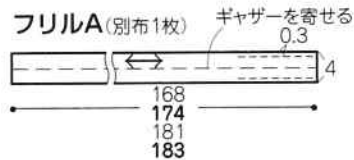
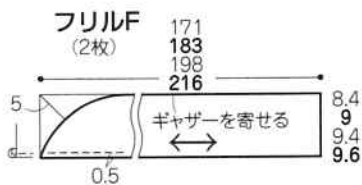
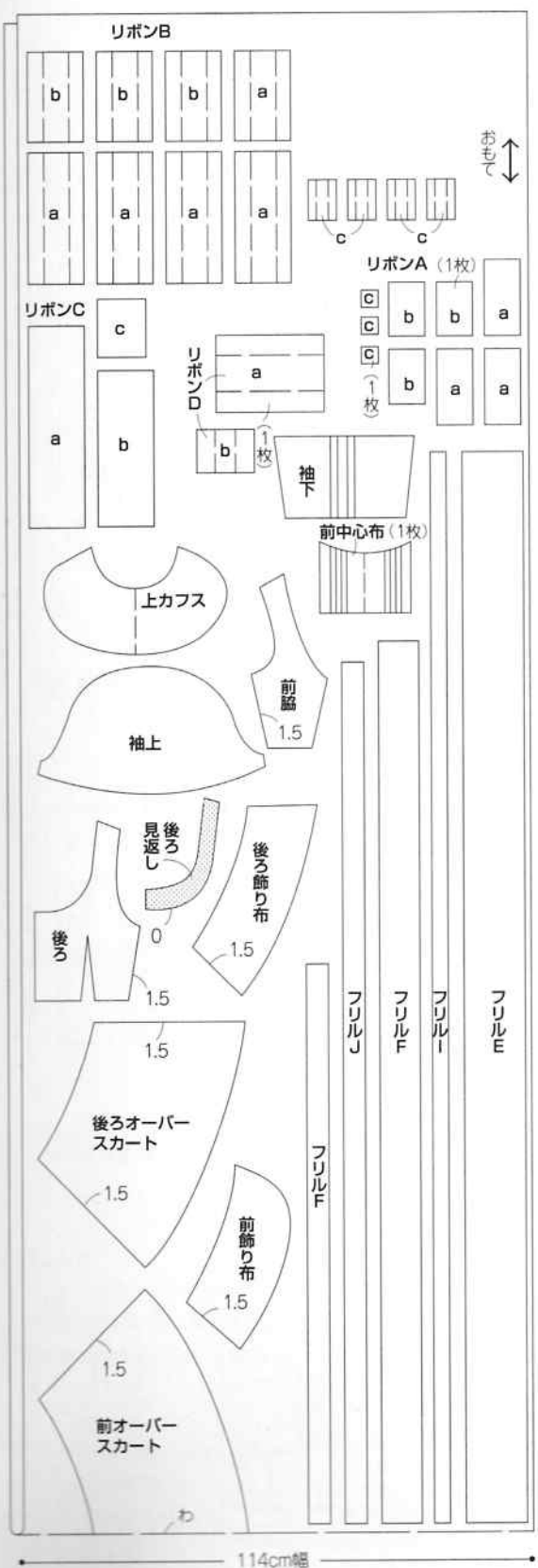

リボンC (2個)

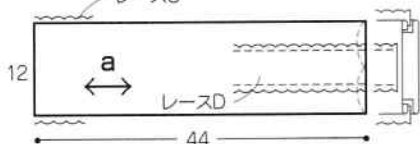
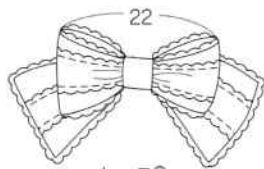

37フリルペチコート製図

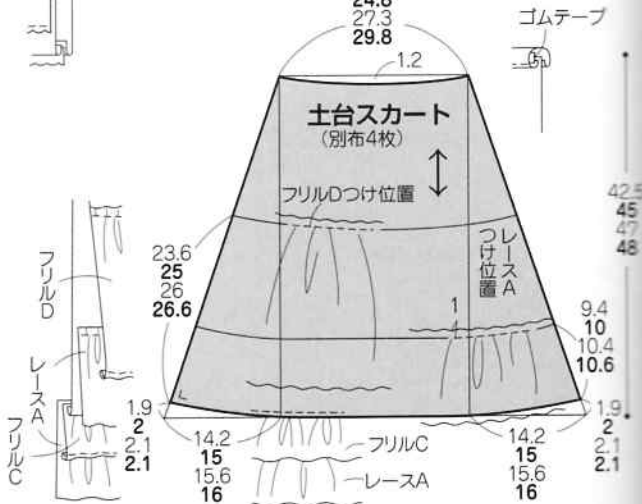
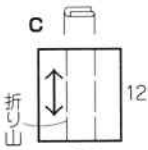
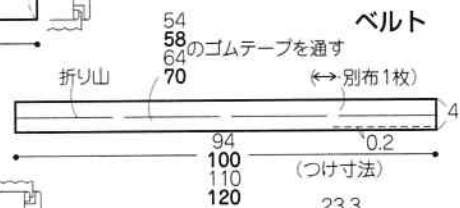
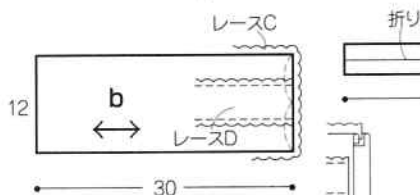

※縫い始める前に接着芯をはり、
布端にジグザグミシンをかける

36の作り方

■ = 接着芯をはる位置

36・37別布の裁ち方

1.前身頃を作る

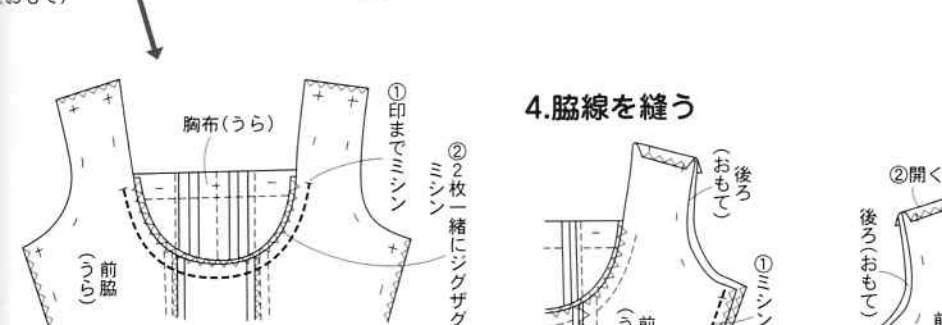
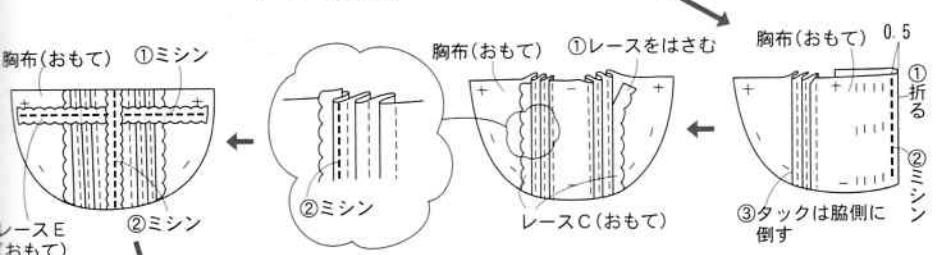
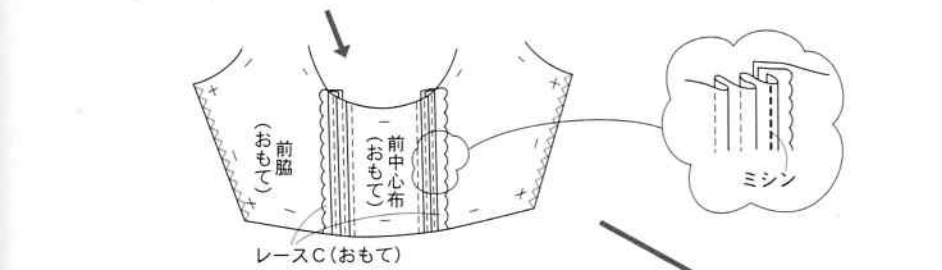
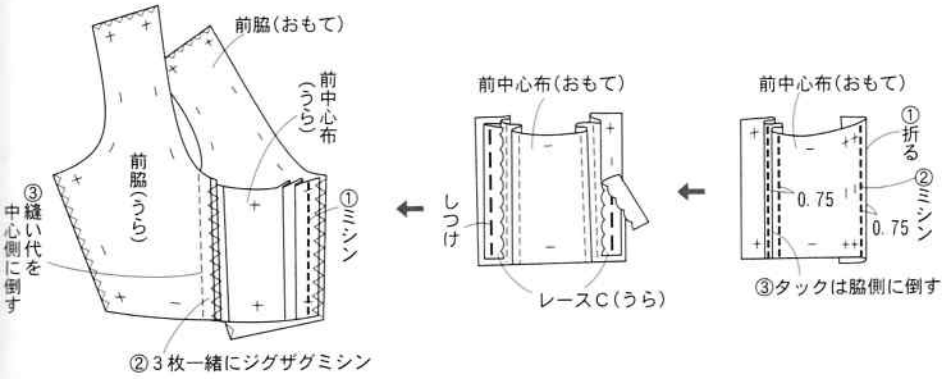

2.ダーツを縫う

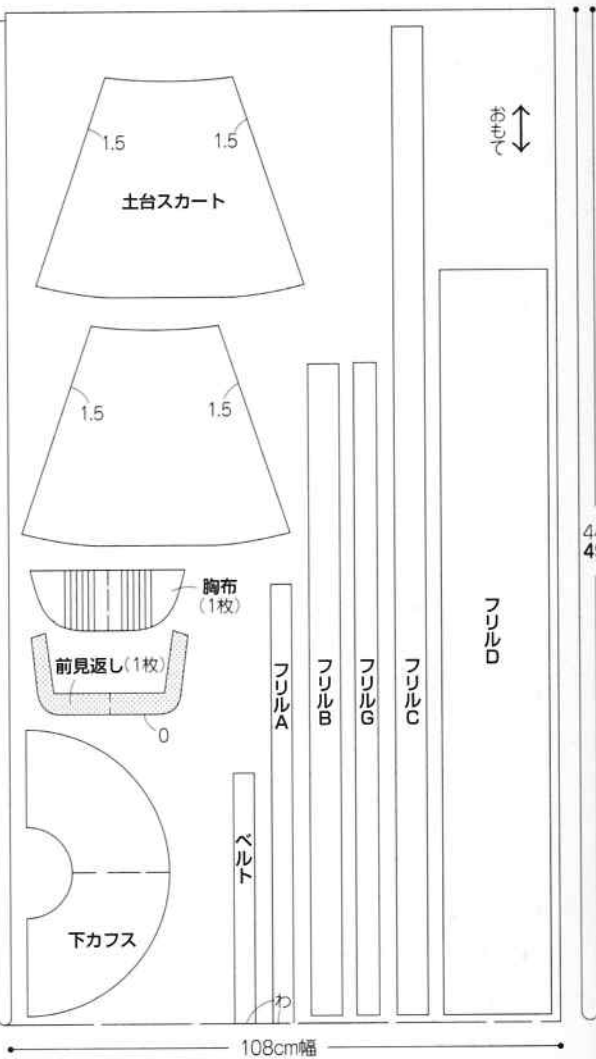

※数字のないところは1cmの縫い代をつけます。

440
490

3.肩線を縫う

4.脇縫い代を倒す

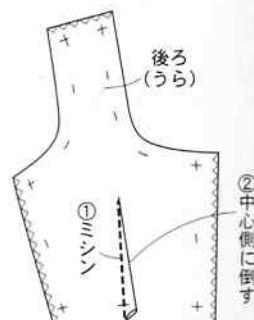
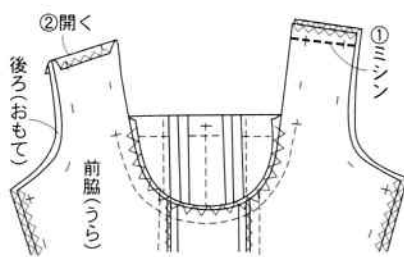

5.オーバースカートをを作る

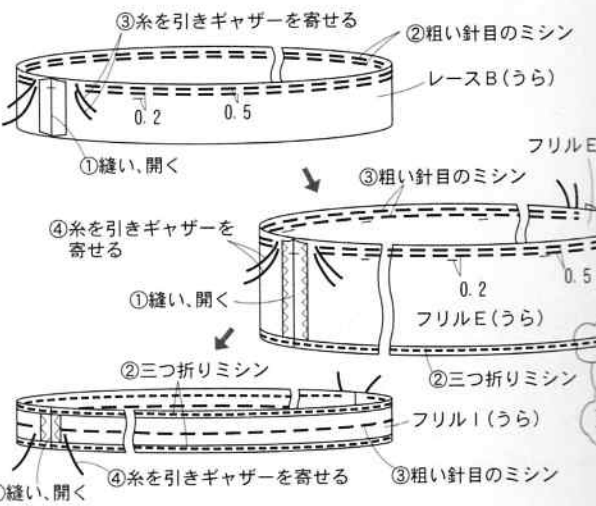
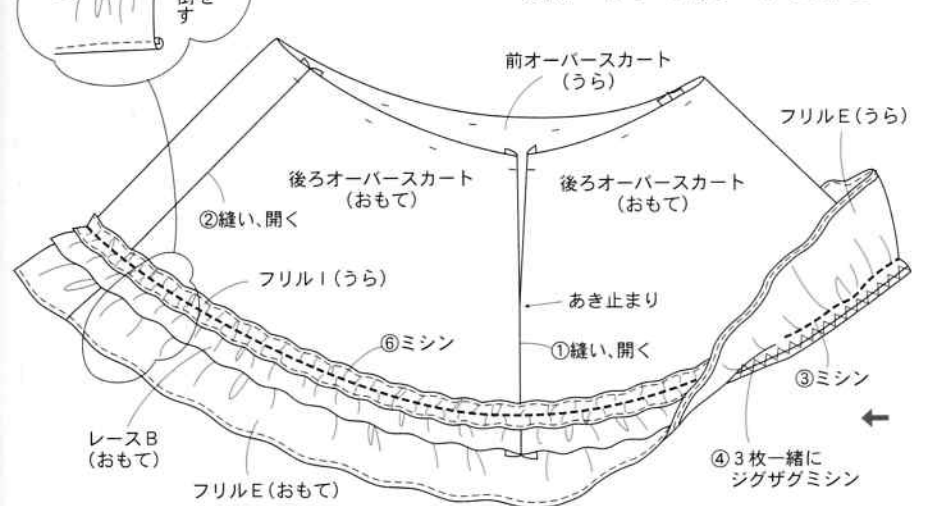

6. 飾り布をつける

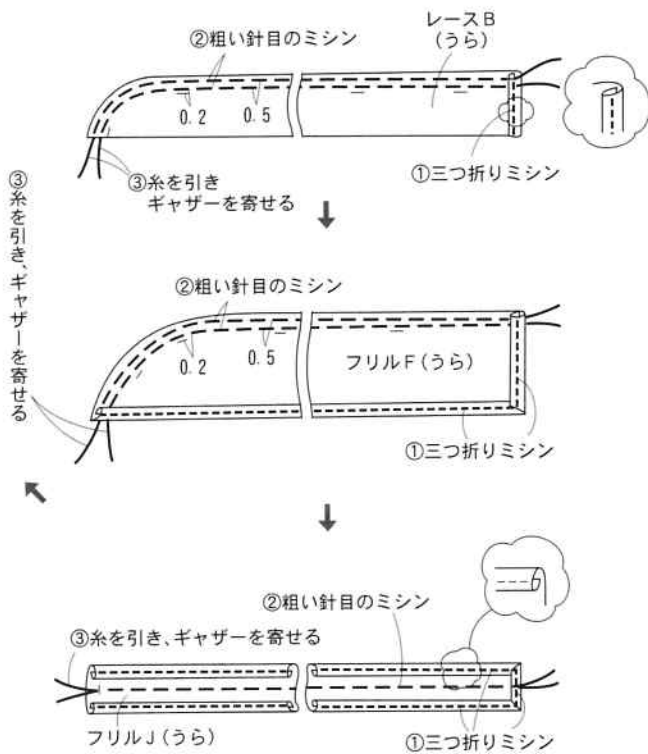
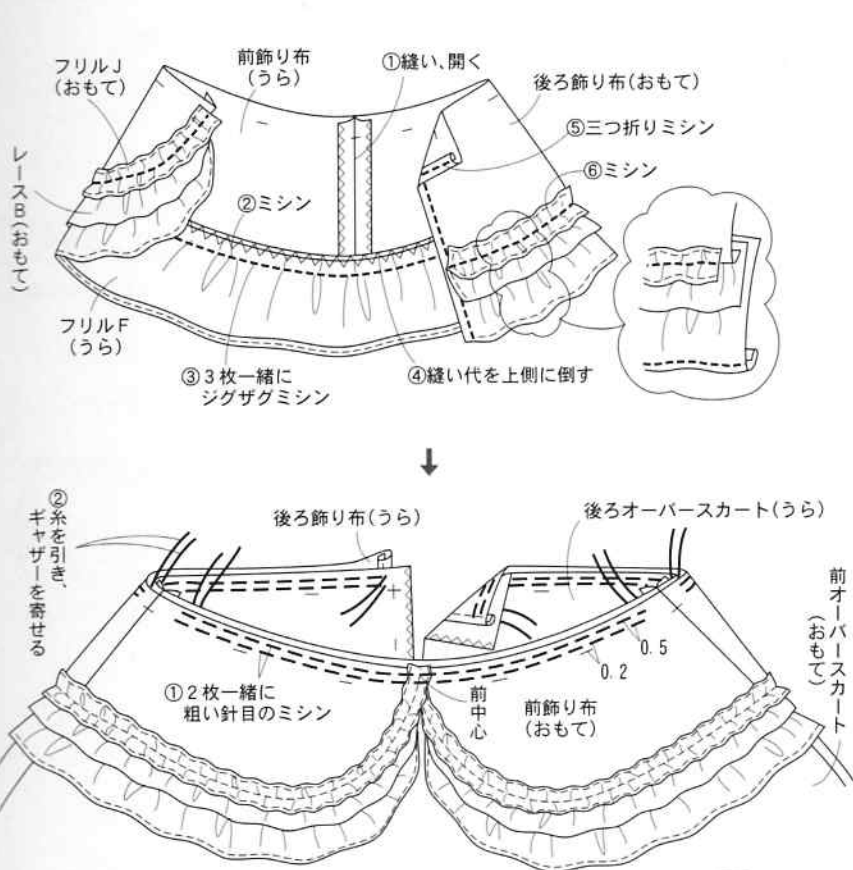

7. ウエストを縫い合わせる

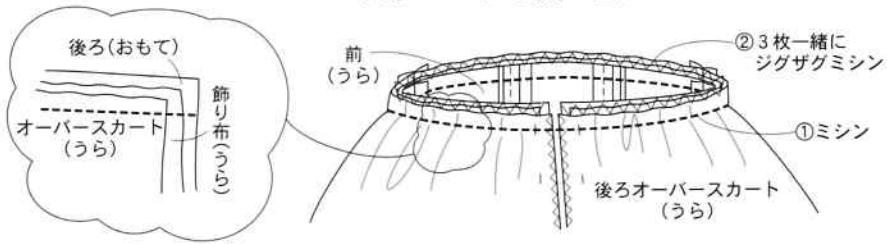

8. コンシールファスナーをつける (79ページ参照)

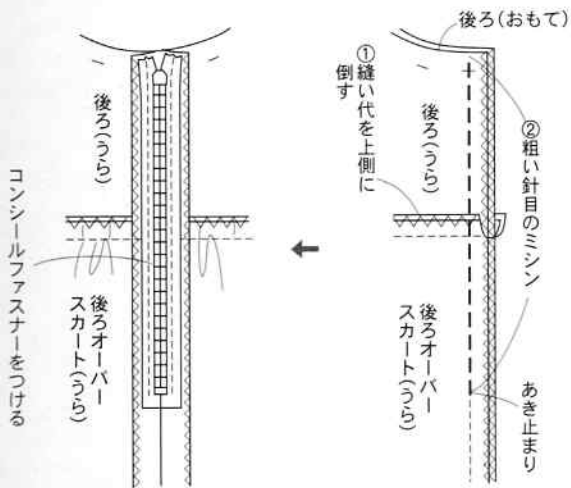

10. 見返しをつける

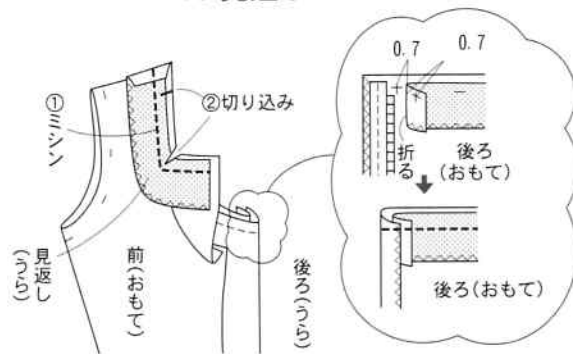

9. 見返しを作る

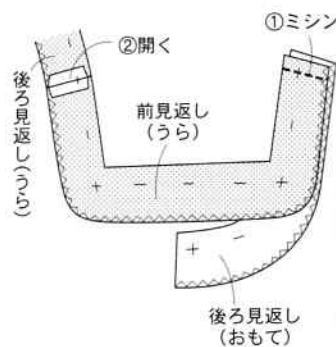

11. 衿ぐりにレースB・フリルAを作り、つける

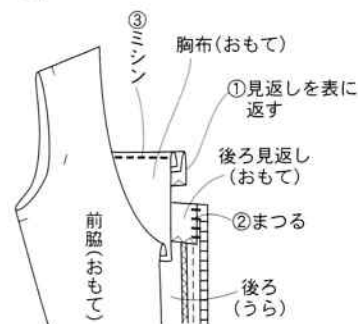
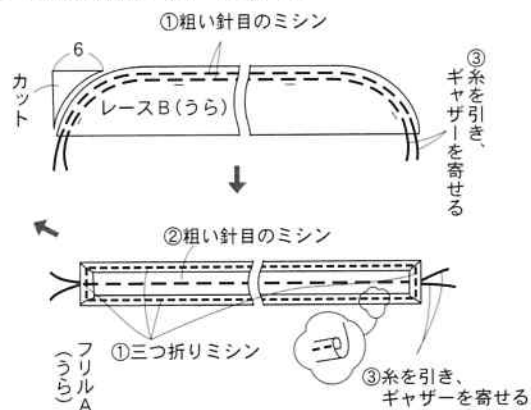
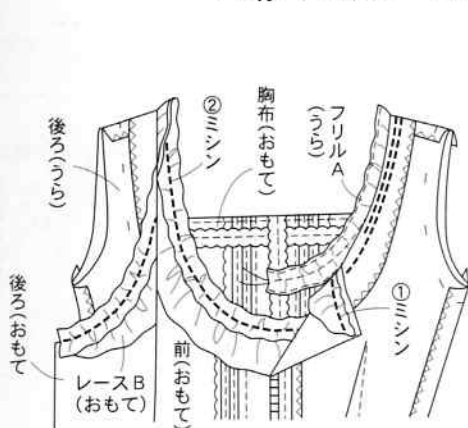

18.でき上がり

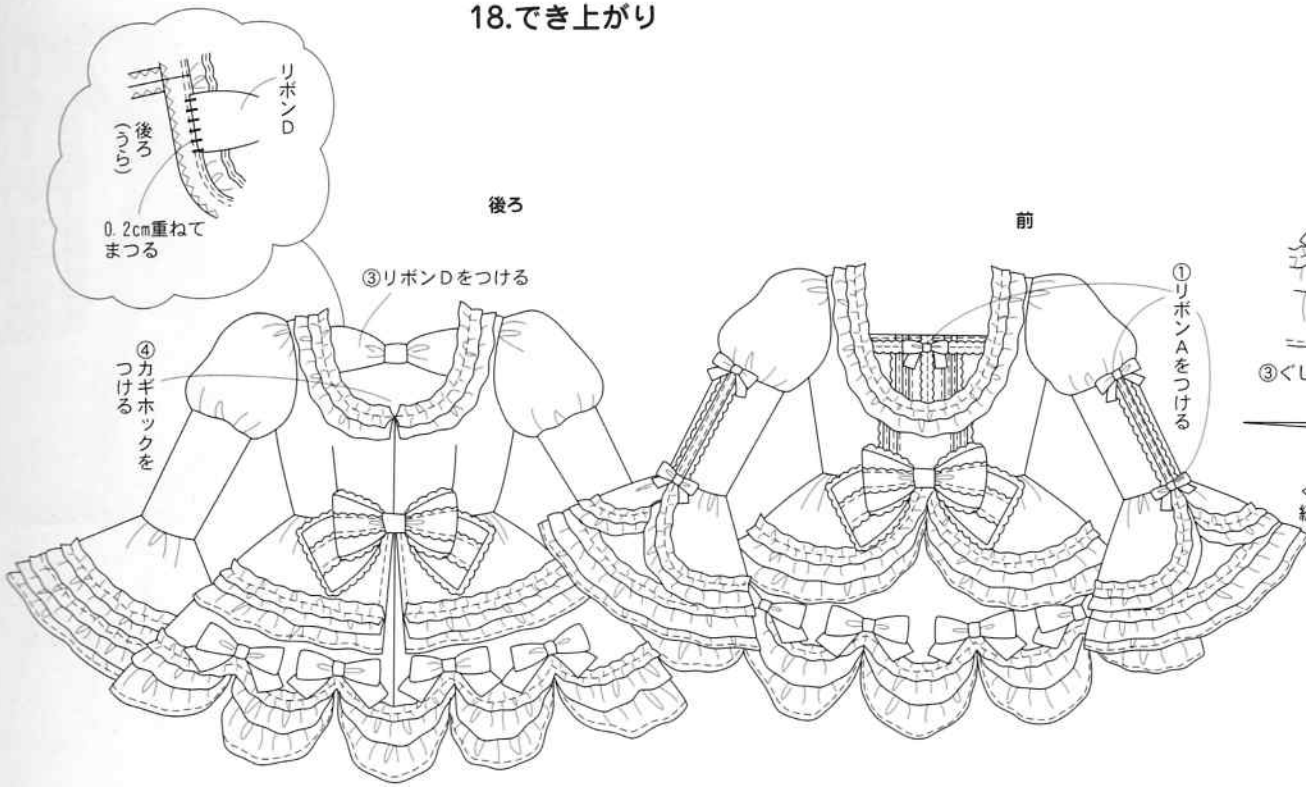

17.リボンBをつける

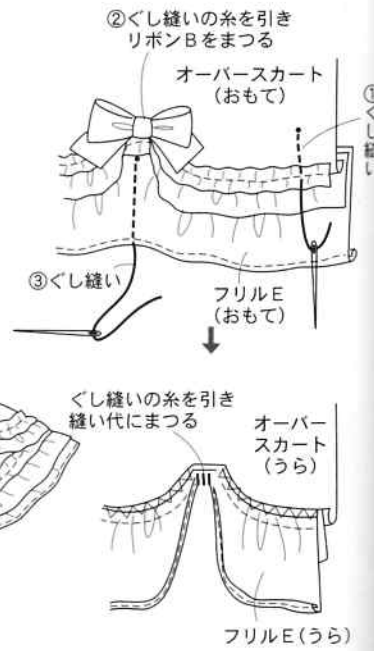

2.土台布を作り、つける

37の作り方

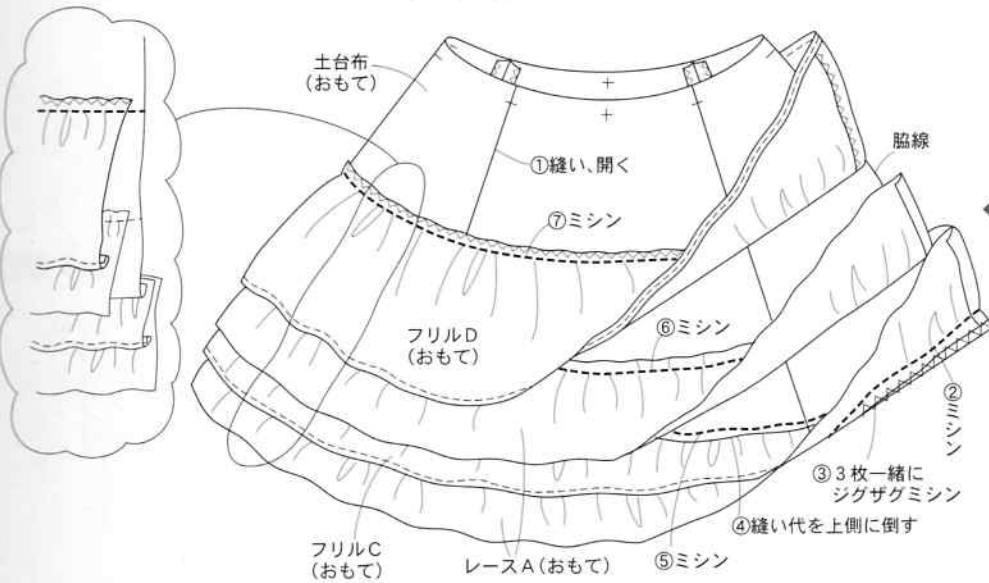

1.フリルを作る

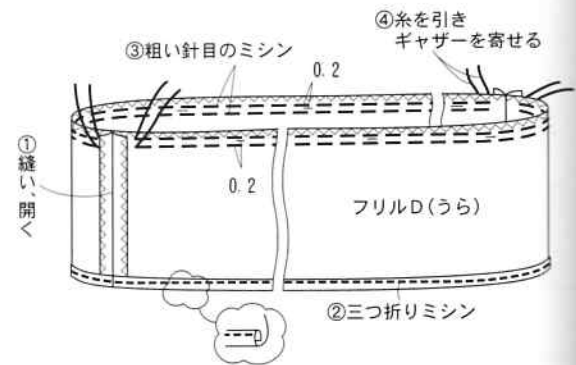

※レースAはオーバースカートのレースBと同様に縫う
 ※フリルCはオーバースカートのフリルEと同様に縫う

3.ベルトを作り、つける

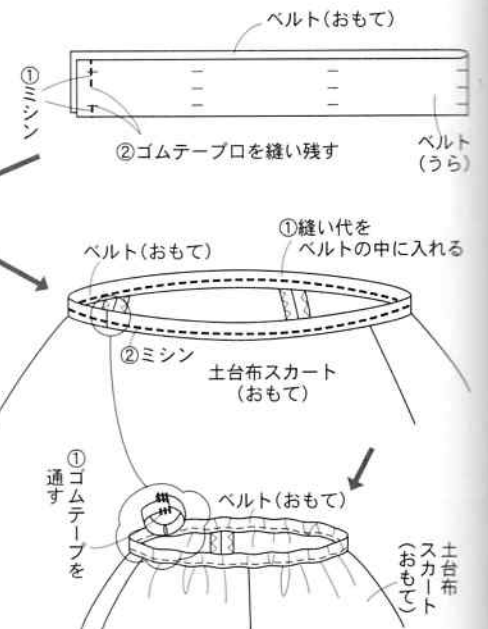

4.でき上がり

